

The Wood Panelling Professionals

V3.23



WoodPanel.co.uk



Technical Specs



@WoodPaneluk





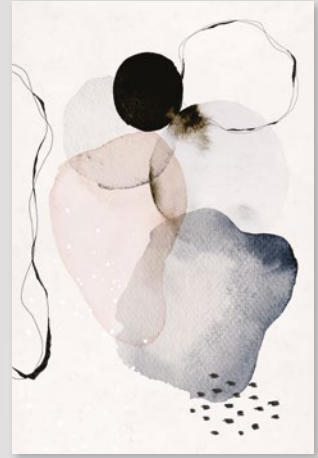







PDF Catalogue



We live and breathe innovation !!!



C O N T E N T S

Our Story		5
Luminar Skirting Board - New Product		6-7
Serene Wood Panel - Style 125		8-9
Purity Wood Panel - Style 120		10-11
Magnum Opus Wood Panel - Style 125		12-13
Divergent Wood Panel - Style 124		14-15
Opulant Wood Panel - Style 126		16-17
Synergy Wood Panel - Style 122		18-19
Halcyon Wood Panel - Style 123		20-21
Individual Wood Slats - STR		22
Accessories		23



Preserving nature's beauty
with sustainable wood panels

WoodPanel.co.uk



Our Story...

Clarity Group UK is a renowned company with more than a decade of experience in providing innovative digital signage, event management, interior design and fit-outs.

We are introducing our latest product line, sustainable WoodPanel, which comprises MDF decorative panels that can create a warm and inviting environment in any indoor space. These panels are made from high quality MDF, known for its durability and sustainability.

Our WoodPanel products are available in a wide variety of stunning wood grains and colours, which are carefully crafted to ensure a unique and visually appealing installation every time.

Our panel designs and styles cater to the diverse needs of our clients, which includes smooth panels, grooved panels, and three-dimensional textured panels, available in a range of sizes and finishes.

To learn more about our WoodPanel products, please visit our website.

We are committed to working closely with our clients to create beautiful and natural spaces that leave a lasting impression.



Luminar Skirting Board

**New Product
Launch**

Elevate your space with the Luminar Skirting Board, where aesthetics meet functionality, and your interior comes to life with subtle, ambient illumination. A sophisticated and practical addition to your interior design. Crafted from high-quality MDF, laminated in elegant white colour. The skirting board is ingeniously designed in two parts, allowing for effortless LED strip installation.

It features a precisely engineered groove to seamlessly accommodate the thin LED strip, ensuring a clean and contemporary look. The built-in groove for the LED power cable ensures easy and discreet wiring.



**Exclusive
Design**



Brush Paint



Spray Paint



LED Groove



Wrapped



Fast Install



LED is not included



Luminar Skirting Board - Specifications

Slat Dimensions	115 x 2750 x 18 mm (width x height x thickness)
Weight	2.70 kg each set
Material	Laminated MDF
Maintenance	Clean with a wet cloth or mild detergent spray
Installation	Grab adhesive



LUMI-SKB-W1000

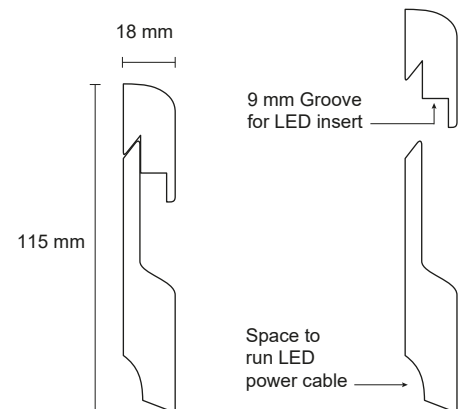
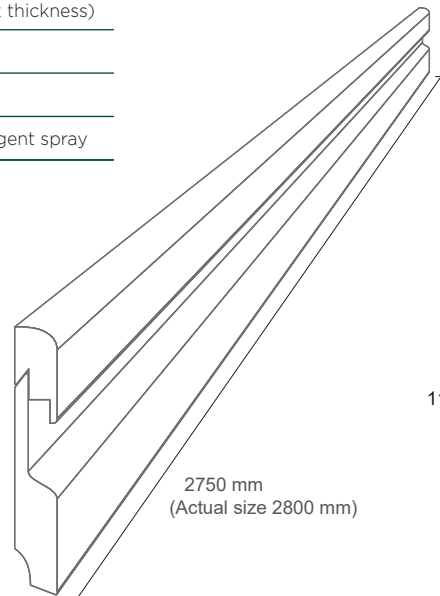

*UK Patent is pending



Serene Wood Panel Collection

Our Serene wood panel collection consists of traditional and contemporary wood grain designs that pay close attention to the source of the wood replication.

We have created a collection that is environmentally focused on the origin of the natural wood design and how this in-turn translates within homes that combine a mixture materials, but still desire want connectivity to the outdoors within the comforts of your home.



Tongue and groove joints

Did you know?

Wood Panels are Eco-Friendly:
Wood is a renewable resource, making wood panels an environmentally friendly choice for interior decor and construction.



H1137-125



H3734-125



H1176-125



H1714-125



H3158-125



H1636-125



H3395-125



H1113-125



H3309-125



H1334-SOFT-125



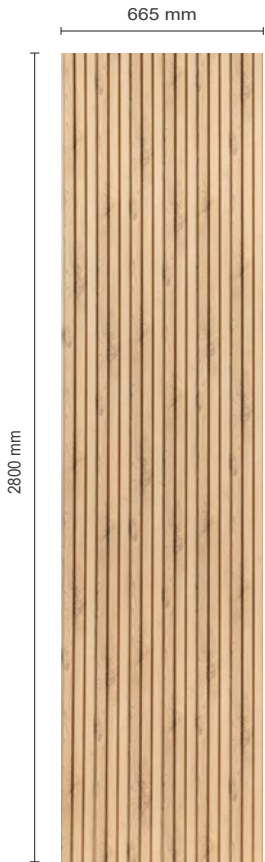

Size from each box

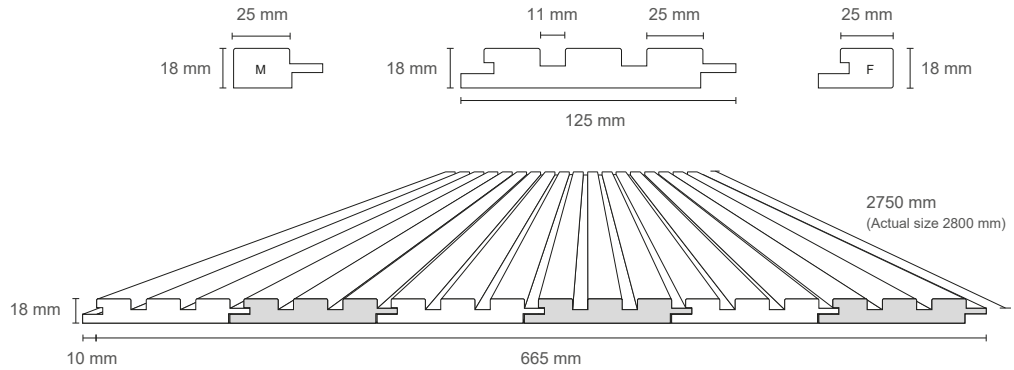

Serene Wood Panel Collection - Specifications

Panel Dimensions 125 x 2750 x 18 mm (width x height x thickness)

Weight	3.20 kg each panel	Quantity	6 panels in a box
Material	Laminated MDF	Area Coverage	665 x 2750 mm = 1.83 sqm
Maintenance	Clean with a wet cloth or mild detergent spray		
Installation	Grab adhesive or mechanical fixation (such as screws and nails) on wall or surface.		
Accessories	Top and bottom trims, male and female end caps, 90 angle, rigid inserts, LED, light diffuser		

Accessories

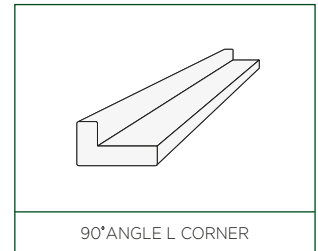
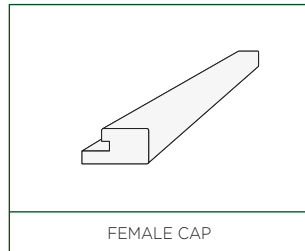
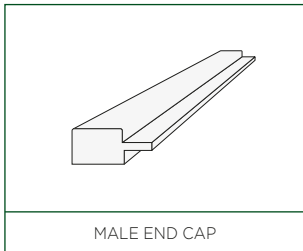



Purity Wood Panel Collection

Our Purity wood panel collection is a practical wood grain design that hones in on the purpose to transform your room into a functional, adaptable and complimentary living space that welcomes a mixed functionality and experimentation to suit the needs for your home. Our Purity collection is a bold, in-your-face wood design that is polarizing in style, yet subtle in charm.

We have created a collection that is simple and clean that will appeal to admirers of purpose built room that open up your floor space, whilst affording you the freedom to interconnect your room through considered synergy that showcases your rooms aesthetic language with sensibility to your desired taste and character imprint.

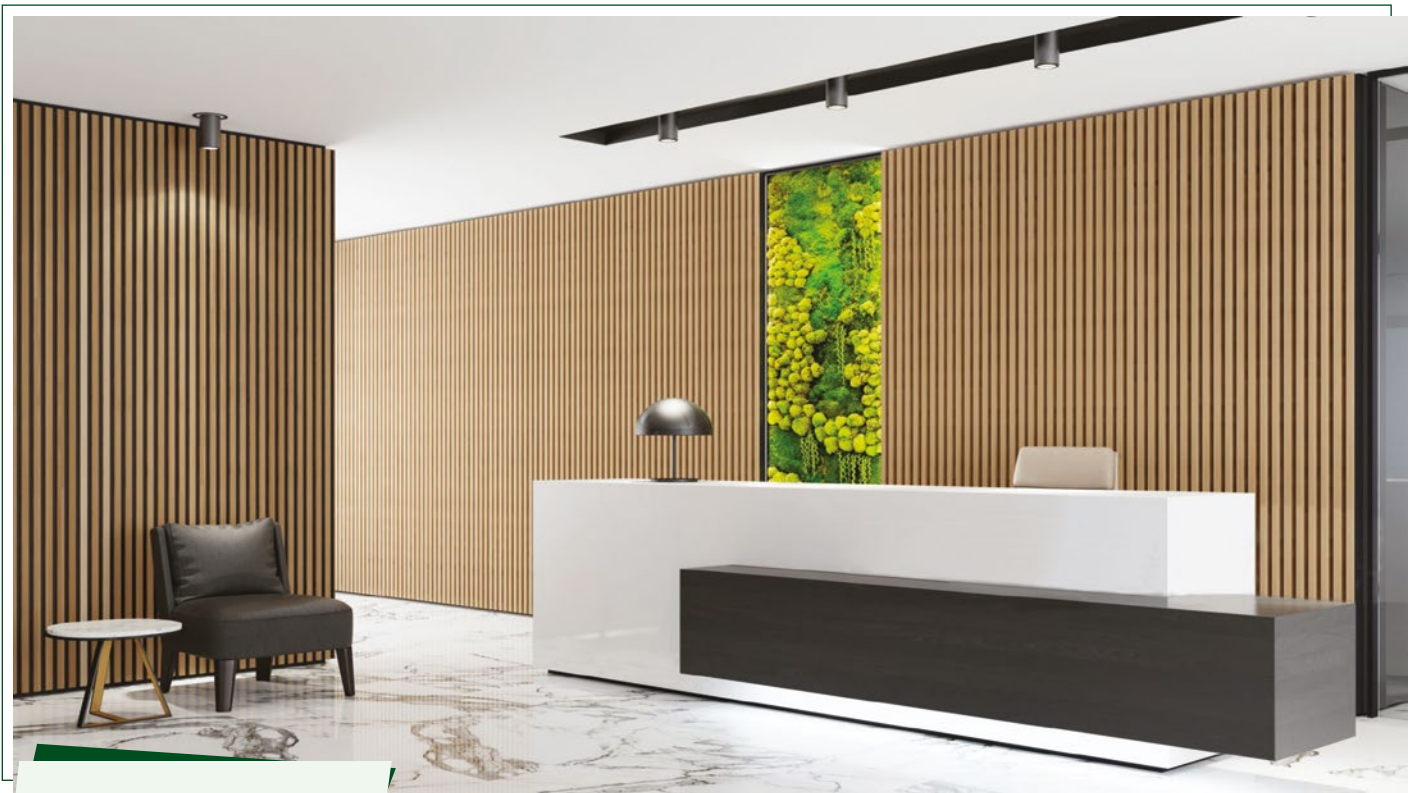

Did you know?

Wood Panels are Eco-Friendly; Wood is a renewable resource, making wood panels an environmentally friendly choice for interior decor and construction.



H3349-BLK-120



H3395-BLK-120



H3734-BLK-120

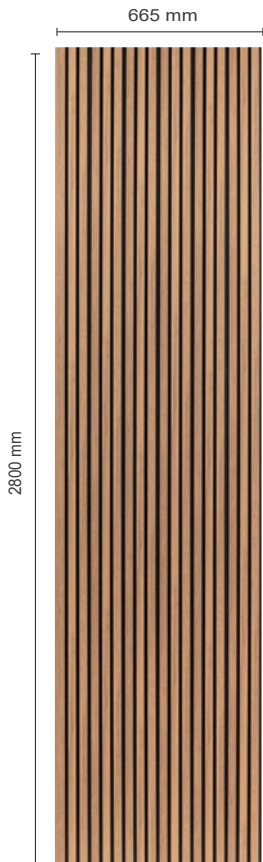

Size from each box

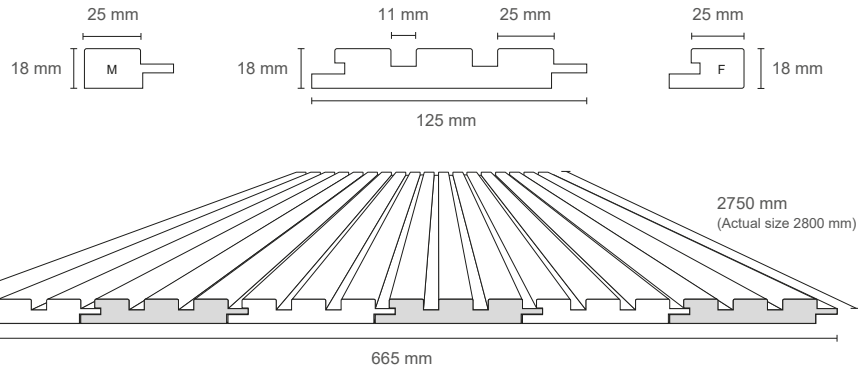

Purity Wood Panel Collection - Specifications

Panel Dimensions 125 x 2750 x 18 mm (width x height x thickness)

Weight 3.20 kg each panel **Quantity** 6 panels in a box

Material Laminated MDF **Area Coverage** 665 x 2750 mm = 1.83 sqm

Maintenance Clean with a wet cloth or mild detergent spray

Installation Grab adhesive or mechanical fixation (such as screws and nails) on wall or surface.

Accessories Top and bottom trims, male and female end caps, 90 angle, rigid inserts, LED, light diffuser

Accessories

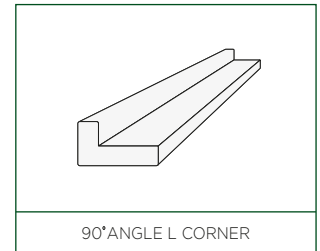
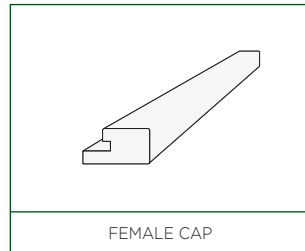
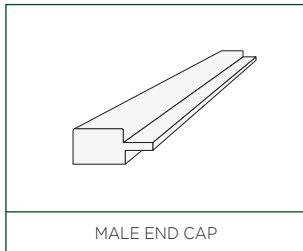



Magnum Opus Wood Panel Collection

Our Magnum Opus wood panel collection is a luxurious range of naturally textured wood grain panels that are striking in statement and embedded in a historically classical design that is undeniable at first glance.

We have created a range to indulges your senses through its connection to inspired great works of art that are meticulously curated with a mature approach to redefining your visual language of extravagant living.

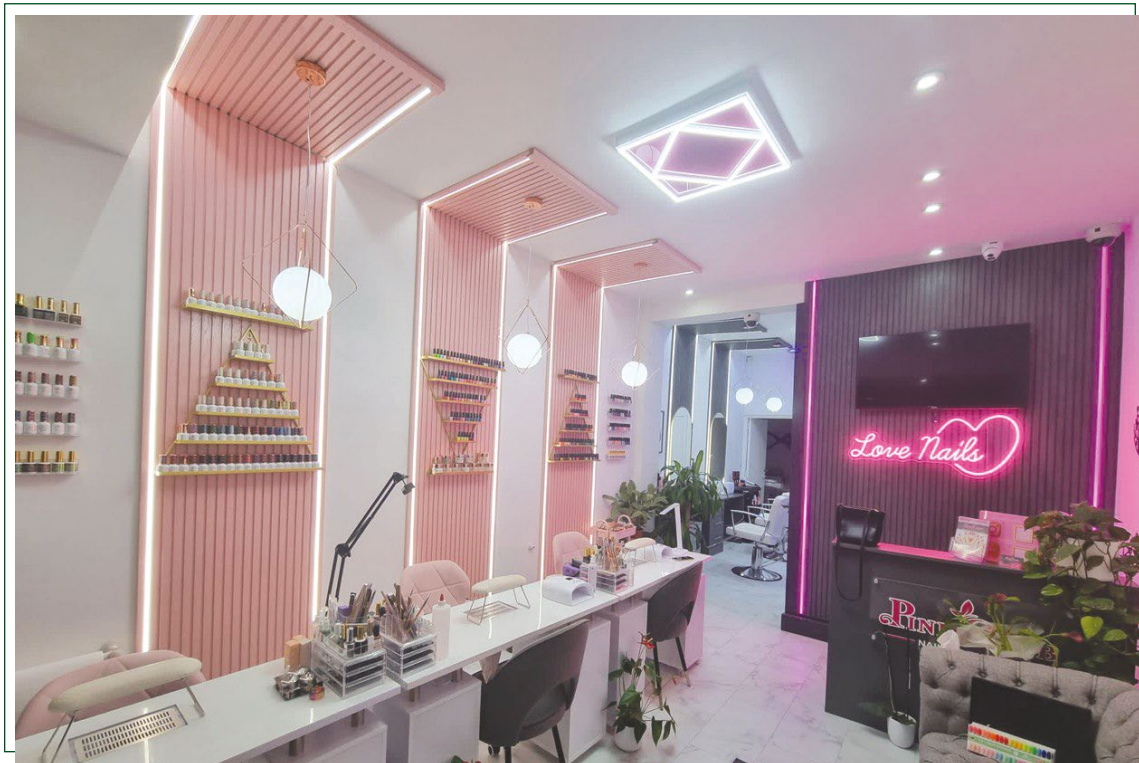

MARBLE-BLUE-125



MARBLE-GOLD-125



U363-125-PT



U504-125-PT



U960-PAT-125



W1000 -125



U899-SOFT-125





Size from each box

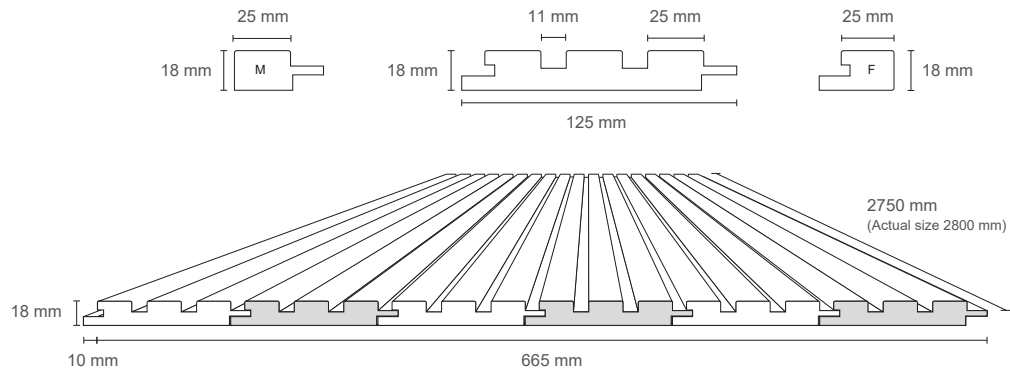

Magnum Opus Wood Panel Collection - Specifications

Panel Dimensions	125 x 2750 x 18 mm (width x height x thickness)		
Weight	3.20 kg each panel	Quantity	6 panels in a box
Material	Laminated MDF	Area Coverage	665 x 2750 mm = 1.83 sqm
Maintenance	Clean with a wet cloth or mild detergent spray		
Installation	Grab adhesive or mechanical fixation (such as screws and nails) on wall or surface.		
Accessories	Top and bottom trims, male and female end caps, 90° angle, rigid inserts, LED, light diffuser		

Accessories

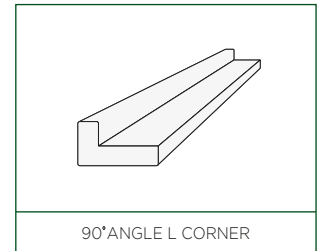
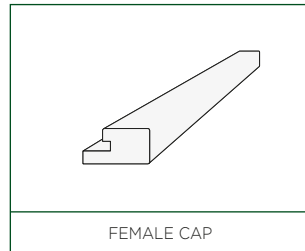
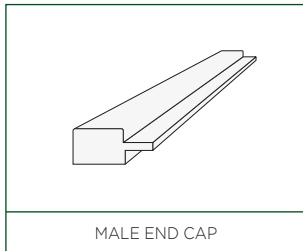



Divergent Wood Panel Collection

Our Divergent wood panel collection has natural wood grain designs that fuses organic textures with a contemporary appreciation to evolving rooms through decisive colour matching.

You will notice the natural wood grain textures are prominent within this collection to preserve the beauty of the wood as it contrasts the black colour.

This is an intentional design aesthetic that guarantees a continuous pattern throughout your project, resulting in a fusion of the old and the new working together in uniformed harmony.



H1176-BLACK-124



H1636-BLACK-124



U732-BLACK-124



H1334-BLACK-124



Did you know?

We manufacture bespoke wood panels in various different patterns, colours, shades and surface finishes to match your project specific requirements.

Please consult your local suppliers or contact our interior design team for free advice.



Size from each box

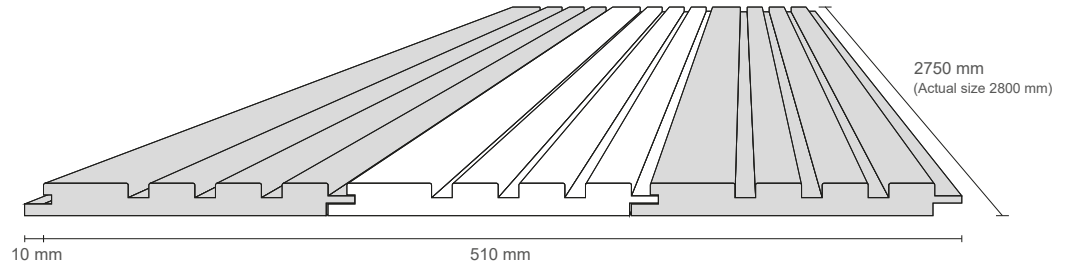
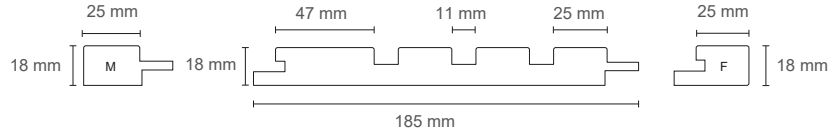

Divergent Wood Panel Collection - Specifications

Panel Dimensions	185 x 2750 x 18 mm (width x height x thickness)		
Weight	5.00 kg each panel	Quantity	3 panels in a box
Material	Laminated MDF	Area Coverage	510 x 2750 mm = 1.40 sqm
Maintenance	Clean with a wet cloth or mild detergent spray		
Installation	Grab adhesive or mechanical fixation (such as screws and nails) on wall or surface.		
Accessories	Top and bottom trims, male and female end caps, 90 angle, rigid inserts, LED, light diffuser		

Accessories

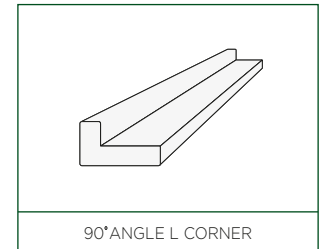
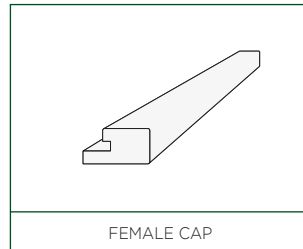
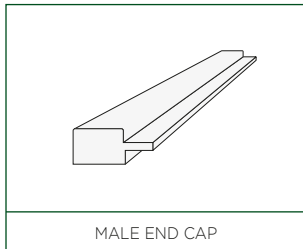



Opulent Wood Panel Collection

Our opulent wood panel collection is visually stunning and the perfect for introducing a more traditional look to a luxurious and modern themed design scheme. The distinct appearance elevates a floor to a more luxury standard. The physical characteristics of the wood grain vary from a rich dark brown to more of a chocolate hue, which creates a truly unique pattern and appearance through its large knots that swirl through the wood.

Our collection comprises of close attention to detail when highlighting the dark tones within the captivating wood grain. The distinct appearance has an unmistakably elevated and well-appointed elegance that is reminiscent of dark chocolate description, which creates a well thought out and intended character profile suited to homes that desire a certain level of class and sophistication.

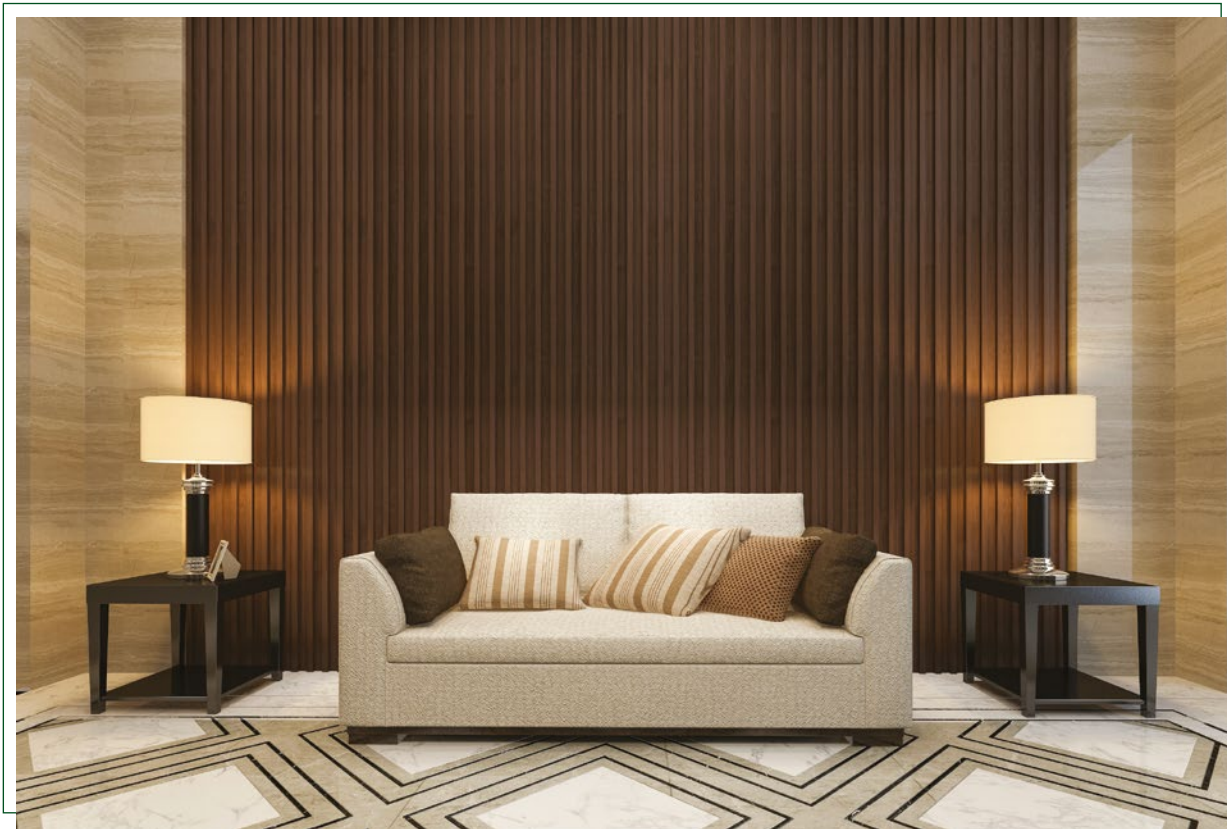

H3702-126



Size from each box

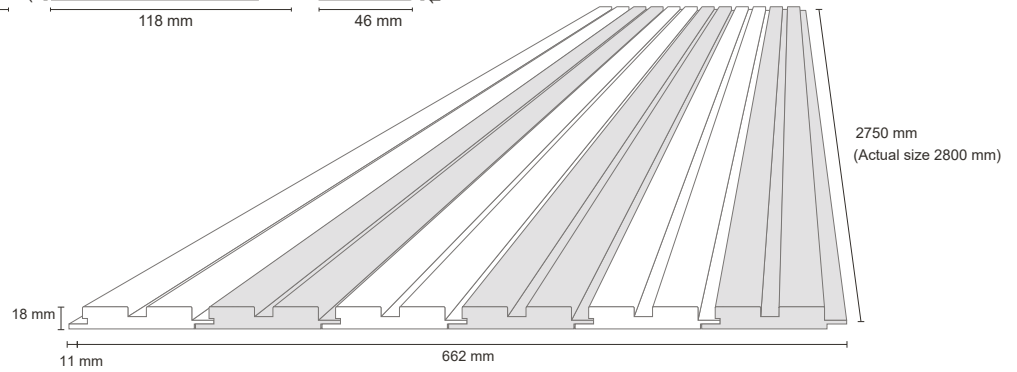
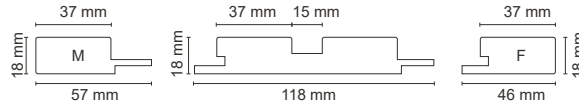

Opulent Wood Panel Collection - Specifications

Panel Dimensions	118 x 2750 x 18 mm (width x height x thickness)		
Weight	3.30 kg each panel	Quantity	6 panels in a box
Material	Laminated MDF	Area Coverage	662 x 2750 mm = 1.82 sqm
Maintenance	Clean with a wet cloth or mild detergent spray		
Installation	Grab adhesive or mechanical fixation (such as screws and nails) on wall or surface.		
Accessories	Top and bottom trims, male and female end caps, 90 angle, rigid inserts, LED, light diffuser		

Accessories

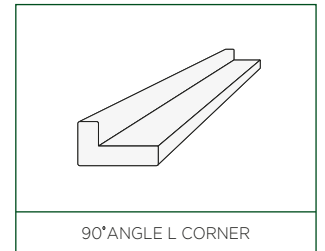
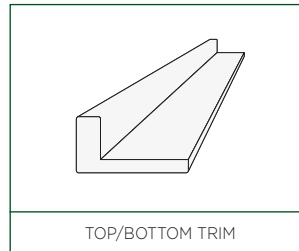
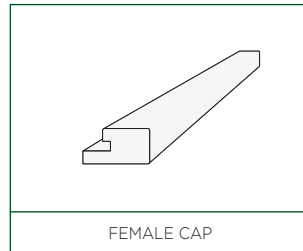
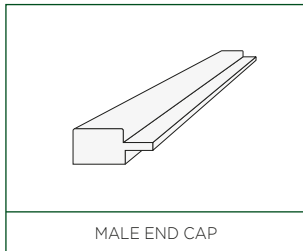



Synergy Wood Panel Collection

Our Synergy wood panel design will transform your living space into a geometric wonder of contemporary art design with the intention of highlighting the asymmetrical accents that speak to your room.

Whether you're a minimalist in aesthetic or a maximalist in visual spectacle... our Synergy panels will draw your eyes into the finer details within your living space without obscuring the subtly within your design aspirations.

Our MDF wall panels are sustainable, offer superior soundproofing, and are fully customisable to meet your size requirements.



U504-S-122



U606-S-122



U963-S -122



U222-S -122



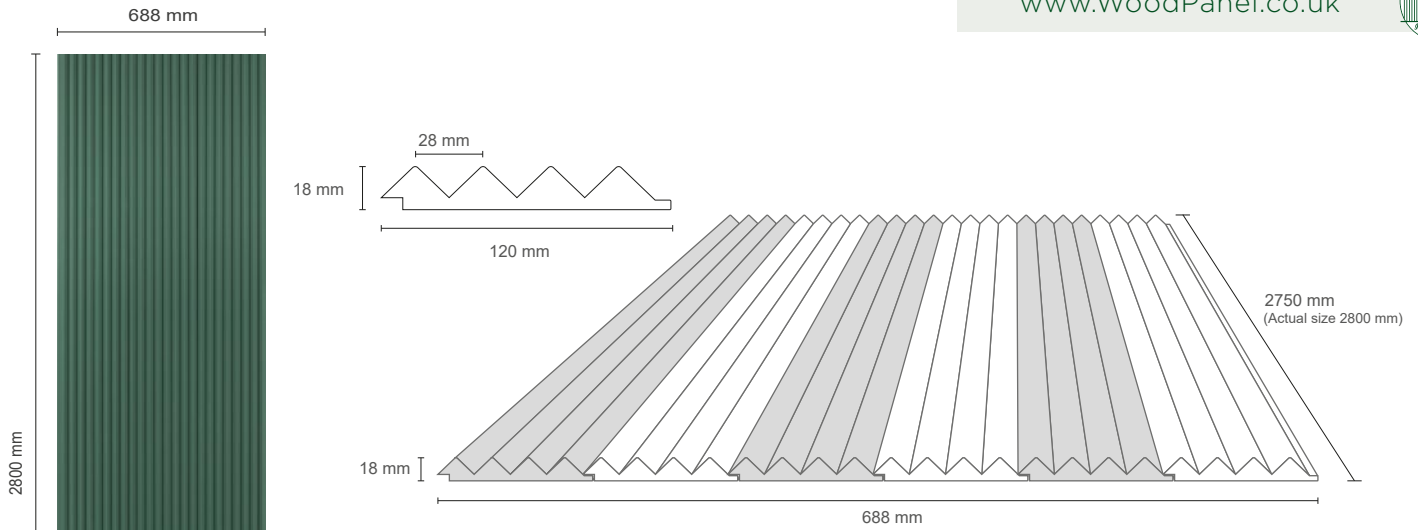

Synergy Wood Panel Collection - Specifications

Panel Dimensions	120 x 2750 x 18 mm (width x height x thickness)		
Weight	2.80 kg each panel	Quantity	6 panels in a box
Material	Laminated MDF	Area Coverage	688 x 2750 mm = 1.89 sqm
Maintenance	Cleaning with wet cloth or mild detergent spray		
Installation	Grab adhesive or mechanical fixation (such as screws and nails) on wall or surface.		
Accessories	Top and bottom trims, male and female end caps, 90 angle, rigid inserts, LED, light diffuser		

Size from each box

Easy DIY Installation

Elevate your space with ease using your preferred method to install all kind of our wood panels.

- Grab Adhesive
- Nail gun
- Drill and Screw
- Hammer and nails

Simple maintenance ensures long-lasting charm. Unleash your inner DIY enthusiast today!





Halcyon Wood Panel Collection

Our Halcyon wood panel collection provide a modern alternative to traditional wood panelling design by focusing on the tactile and sensory experiences that resonate feelings of warmth and texture to your room.

We have created a collection of panels that differ in terms of their appearance, from simple and soft wood grain patterns to more striking rustic aesthetic, making your choices adaptable to your desired comfort environment. Our Halcyon panel has endless design possibilities and can be used as a floor to ceiling panel and welcoming addition to enhance up-scaled furniture upholstery, creating an inviting and accommodating room to relax in.



U504-S-123



U606-S-123



U963-S-123



U222-S-123



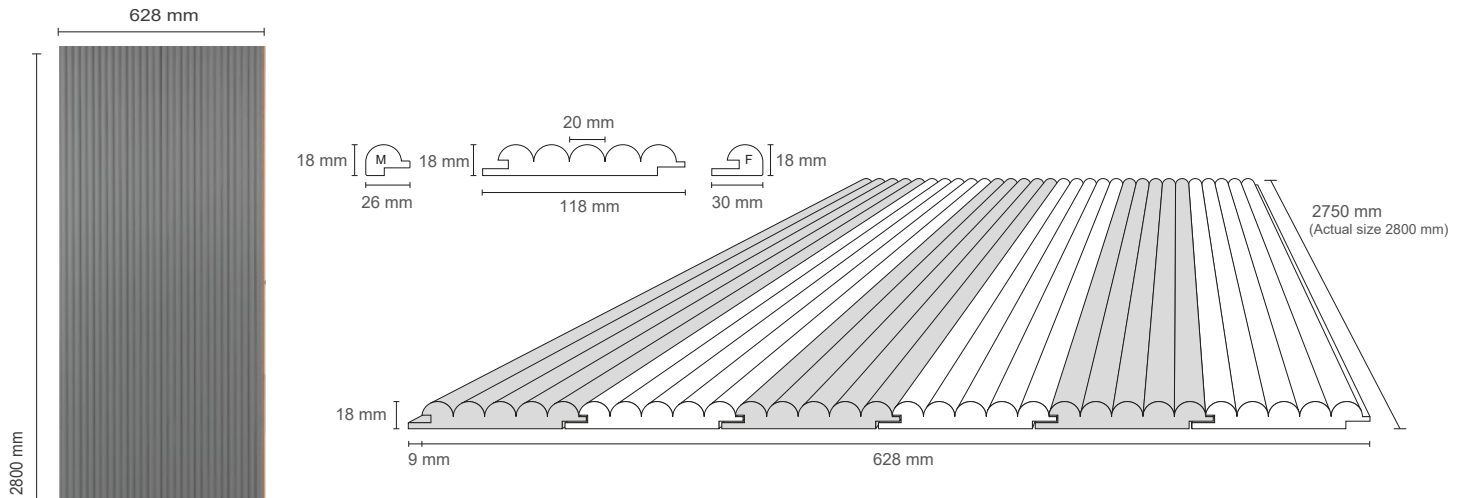

Halcyon Wood Panel Collection - Specifications

Panel Dimensions	118 x 2750 x 18 mm (width x height x thickness)		
Weight	3.50 kg each panel	Quantity	6 panels in a box
Material	Laminated MDF	Area Coverage	628 x 2750 mm = 1.73 sqm
Maintenance	Clean with a wet cloth or mild detergent spray		
Installation	Grab adhesive or mechanical fixation (such as screws and nails) on wall or surface.		
Accessories	Top and bottom trims, male and female end caps, 90 angle, rigid inserts, LED, light diffuser		

Size from each box

Accessories

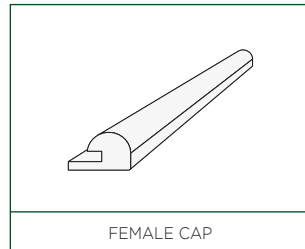
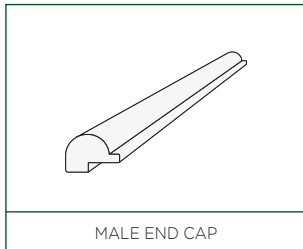

Did you know?

Our complete product range, technical specifications and installation guide are available on our website.

You can place online orders for wood panel samples. Please consult your local suppliers or contact our interior design team for free advice.



Individual Wood Slats

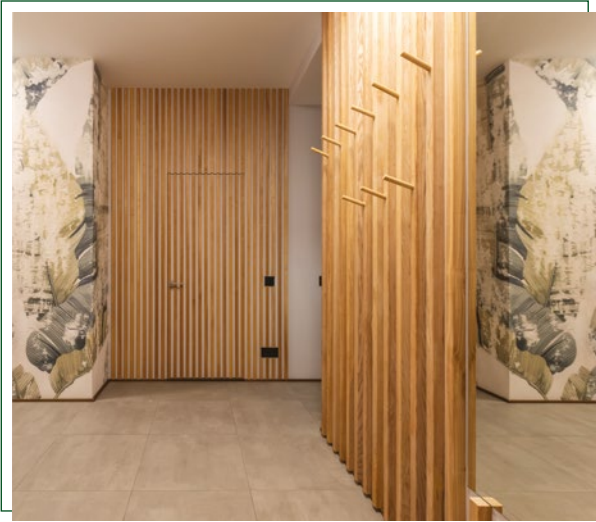

Patterns

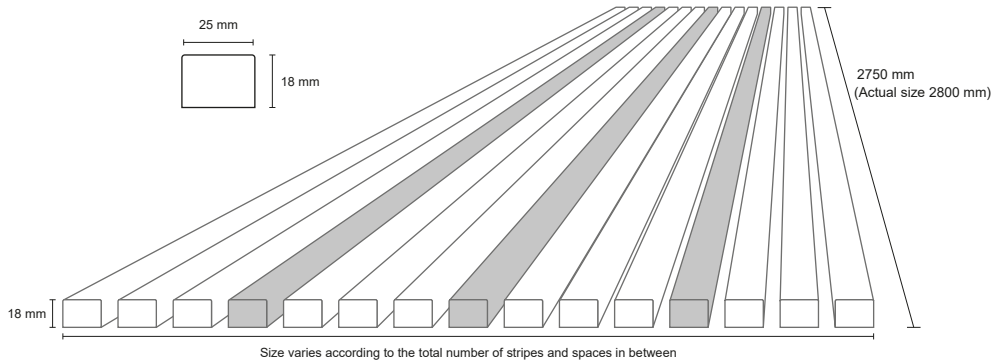

Accessories

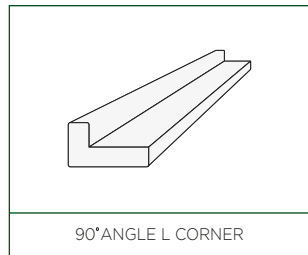
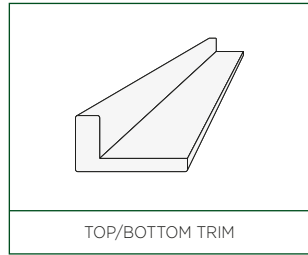

Individual Wood Slats - Specifications

Slat Dimensions	25 x 2750 x 18 mm (width x height x thickness)		
Weight	0.92 kg each slat	Quantity	Sold in Units
Material	Laminated MDF	Area Coverage	As per number of stripes and spaces in between
Maintenance	Clean with a wet cloth or mild detergent spray		
Installation	Grab adhesive		



Accessories

LED Strip Lighting

Our specially designed LED lumination will add a spectacular touch to your wall. LED Strips are available in two versions: SMD and COB

The LED color options:

- Cool white
- Warm white
- RGB
- RGB W



SMD LED



COB LED

All above LEDs are also available in digital programmable strips.

To create a unified illuminated effect (line illumination), cover the LED dots with our specially designed flexible diffuser covers. In some models, after fixing the LED stripes, apply thin bit of mitre glue under the corners, fix the flexible diffuser and spray.



Flexible LED Diffuser

Self Adhesive Inserts

Self adhesive, rigid, flat bar inserts in 280 cm length



Easy DIY Installation

Gold

Silver

Black



Flexible Diffuser



Mitre Adhesive



Grab Adhesives



Cleaning Wipes



Solderless Connector









Transform any space
into a beautiful and
unique environment





WoodPanel.co.uk

Authorised Distributor

The Wood Panelling Professionals